

Residential ESS Lithium-ion Battery

CFE-10H User Manual

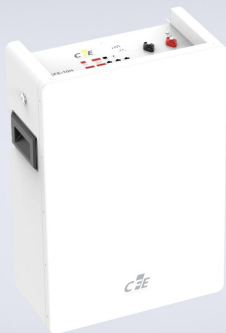

About CFE RESS Li-ion Battery

CFE-10H can be installed in Parallel or Series, more attention should be paid to the DIP and address selection following with part 5.3.2.

About this Manual

The Manual is intended for the CFE-10H Residential ESS, the hybrid inverter and any other equipment are not included.

2023 CF Energy Co., Ltd. All rights reserved.

CF ENERGY CO., LTD. mentioned later is abbreviated as CFE.

This document is provided "as-is." Information in this document, including URL and other Internet Web site references, may change without notice.

Contents

1 Safety Instructions	1
1.1 Important Safety Instructions	1
1.2 Warnings in this Document	1
1.3 Battery handling guide	2
1.4 Response to emergency situations	2
1.4.1 Leaking batteries	2
1.4.2 Fire	2
1.4.3 Wet battery	3
1.4.4 Damaged battery	3
1.5 Installers	3
1.6 Scrap battery	4
1.7 Customer careline	4
2 Product Introduction	4
2.1 Technical data	4
2.2 Indicator and ports	5
2.3 Communication interface plat	6
2.4 How it works	7
2.5 Feature	7
3 Guidance for batteries during shipment	8
4 Installation Prerequisites	8
4.1 Installation location	8
4.2 Installation process	9
4.3 Installation materials	9
4.4 Tools	10

4.5 Safety instruments	10
4.6 Communication cable	11
4.7 Storage	11
5 Battery Installation	11
5.1 Package items	11
5.2 Checks before installation	12
5.3 Installation of the battery	12
5.4 Cable connections	17
6 Settings for CAN /485 bus pins	18
7 Commissioning	18
7.1 Commissioning battery	19
7.2 Shutting down battery	19
Warranty of Residential ESS	20
RED Declaration of Conformity (DoC)	24

1 Safety Instructions

1.1 Important Safety Instructions

This manual contains important instructions for:







CFE-Residential ESS Lithium-ion Battery product

This manual must be followed when installing and using this product.

The product is designed and tested in accordance with international safety requirements IEC 62619/IEC 62040/UL1973, but as with all electrical and electronic equipment, certain precautions must be observed with regard to product installation and/or operation. To reduce the risk of personal injury and ensure safe installation and manipulation of the product, it is required to carefully read and follow all instructions, cautions and warnings in this manual.

1.2 Warnings in this Document

A warning describes a possible hazard to equipment or personnel, which calls attention to a procedure or practice. Improper enforcement or compliance with warnings could result in damage or destruction of part or all of the equipment and/or other equipment connected to the equipment or personal injury.

Symbol	Description
	Beware of risk of electric shock
	Heavy enough may cause severe injury
	Keep the battery away from open flame or ignition sources
	Keep the battery away from children
	Do not dispose of the product with household waste
	Recycling
	Read this manual before installation and operation

For safety reasons, installers are responsible for familiarizing themselves with the contents of this manual and all warnings before performing installation.

If the battery is not used for more than 6 months from the production date, it shall be charged once. The failure caused by the overdue failure to perform the standard operation is not within the scope of warranty.

1.3 Battery handling guide

Use the battery pack only as directed.

1.4 Response to emergency situations

The CFE-Residential ESS Lithium-ion Battery is designed with multiple safety strategies to prevent hazards resulting from failures. However, Cannot guarantee their absolute safety for uncertain situations.

1.4.1 Leaking batteries

If the battery pack leaks electrolyte, direct contact with the leaking liquid or gas must be avoided. Contact with electrolyte may cause skin irritation and chemical burns due to its corrosiveness. If one is exposed to the leaked substance, the following actions should be taken:

Inhalation: Evacuate the contaminated area, and seek medical attention immediately.

Eyes contact: Rinse eyes with flowing water for 15 minutes, and seek medical attention immediately.

Skin contact: Wash the affected area thoroughly with soap and water, and seek medical attention immediately.

Ingestion: Induce vomiting as soon as possible, and seek medical attention immediately.

1.4.2 Fire

In case of a fire, make sure that an ABC or carbon dioxide extinguisher is placed nearby and do not extinguish the fire by water.

WARNING

The battery pack may catch fire when heated above 130°C.

If a fire breaks out where the battery is installed, please take the following actions:

- 1) Extinguish the fire before the battery catches fire.
 - 2) If the battery has caught fire, do not try to extinguish the fire, and evacuate people immediately.
-

Do not approach in case of any contact with poisonous gases once the battery catches fire.

1.4.3 Wet battery

If the battery is wet or submerged in water, do not try to access it. It's proper to contact customer careline or your distributor for technical assistance.

1.4.4 Damaged battery

If the battery is damaged, please contact customer careline or your distributor for appropriate countermeasures as soon as possible, because damaged batteries are dangerous and must be handled with extreme caution. Damaged batteries are not suitable for use and may pose a danger to people or property. If the battery seems to be damaged, it also should be returned to your distributor.

CAUTION

Given the high possibility of damaged batteries exporting electrolyte or flammable gas, the correct action is to contact your distributor for advice and information immediately. Such cases will be addressed within 48h.

1.5 Installers

CFE-Residential ESS Lithium-ion Battery is suggested to be installed by skilled workers or electricians. A skilled worker is defined as a person who has received professional training and qualified electrician or possesses all of the following skills and experience:

- ✓ Knowledge of the functional principles and operation of on-grid energy storage systems.
- ✓ Knowledge of the dangers and risks associated with installing and using electrical devices and acceptable mitigation methods.
- ✓ Knowledge of the installation of electrical devices.
- ✓ Knowledge of adherence to this manual and all safety precautions and optimal practices.

1.6 Scrap battery

For scrap battery, please treat with local laws or regulations to recycle.

1.7 Customer careline

The contact information for technical assistance is given as below. This phone number is available 24/7 and we will register your problems and provide reasonable solutions within 48h.

Customer careline	+86 400 996 8377
-------------------	------------------

2 Product Introduction

2.1 Technical data

Model	CFE-10H
Total Energy*	10.24 kWh
Usable Energy(DC)	8.7 kWh
Max. Discharge Power	5 KW
Rated Capacity	200 Ah
Voltage	48~56 Vd.c
Nominal Voltage	51.2 Vd.c
Operating Condition	Indoor
Charge Operating Temperature	0~45℃
Discharge Operating Temperature	-10~55℃
Dimensions (W*D*H)	700*500*235 mm
Weight	85±1 kg

IP Rating	IP 20
Protective Class	I
Parallel or Series Support	8 Parallel or Series
Relative Humidity (RH)	0~95% (No condensed water)
Cooling Type	Ambient cooling
Case Material	Metal
Color	White
Installation	Wall Mounting
Warranty	5 Years
Communication	CAN/RS485
Protection Mode	Triple Hardware Protection
Battery Protection	Over-Current/ Over-Voltage/ Short Circuit/ Under-Voltage/ Over Temperature
Safety Certificate	UN3480

✦ Testing Conditions Based on Temperature 25°C at The Beginning of Life.

✦ Total Energy/Usable Energy Measured Under Specific Conditions From 0.2C CC/CV

2.2 Indicator and ports

There are six LED indicators on the front of the battery to show its operating status.

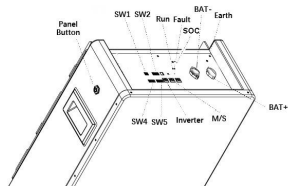
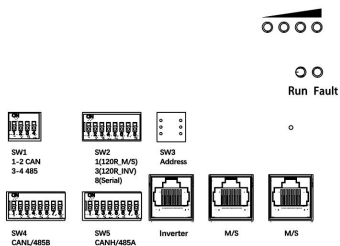

Table 2-1 Designations on the battery

Item	Designation	Definition
1	Running	Battery normally working without fault
2	Fault	Battery is in a warning state, see troubleshooting in Chapter 8
3	SOC	Battery indicator light.

2.3 Communication interface plat



SW1	DIP switch selection for CAN or RS485
SW2	Resistance for communication and DIP switch for parallel/series connection

SW3	Switch for battery's address selection
SW4 & SW5	Communication for battery or master battery with inverter

2.4 How it works

Morning	Afternoon
<p>SOLAR PANELS</p> <p>Residential ESS</p> <p>HYBRID INVERTER</p> <p>LOADS</p> <p>GRID</p>	<p>SOLAR PANELS</p> <p>Residential ESS</p> <p>HYBRID INVERTER</p> <p>LOADS</p> <p>GRID</p>
<p>Optimized self-consumption will be achieved. ESS is used to store excess energy produced by PV system.</p>	<p>Extra energy will be fed into the grid when ESS is fully charged and system has already reached its self-consumption requirement.</p>
Evening	Night
<p>SOLAR PANELS</p> <p>Residential ESS</p> <p>HYBRID INVERTER</p> <p>LOADS</p> <p>GRID</p>	<p>SOLAR PANELS</p> <p>Residential ESS</p> <p>HYBRID INVERTER</p> <p>LOADS</p> <p>GRID</p>
<p>ESS will power the AC load at sunset.</p>	<p>If the ESS capacity is insufficient to meet self consumption requirement, electricity will be obtained from the grid.</p>

2.5 Feature

CFE-Residential ESS Lithium-ion Battery is characterized with:

- ✓ **Energy storage unit:** This battery is suitable for PV solar system compatibility.
- ✓ **Battery management system (BMS):** The battery's built-in BMS monitor prevents the battery from running outside its design limitations.
- ✓ **Expandability:** The battery capacity can be increased by adding another battery of the same batch and specification.

3 Guidance for batteries during shipment

- 1) Cartons that have been crushed, punctured, or torn in such a way that contents are revealed shall be set aside in an isolated area and inspected by a skilled person. If the package is deemed to be not shippable, relevant contents shall be promptly collected and segregated. Meanwhile, it is required to contact the consignor or consignee.
- 2) The DC circuit of Residential ESS has been disconnected before outgoing.
- 3) A precautionary label must be affixed to the shipping carton to alert individuals that the battery within the package has been disconnected; otherwise, the battery should not be transported.
- 4) We have conducted comprehensive tests of our equipment distributed around the world to ensure safety for shipping transport. These products shall be handled with care and immediately inspected if visibly damaged. It needs to contact with customer careline in case of any visible damage to cartons to confirm whether the battery could be used safely or not.

4 Installation Prerequisites

4.1 Installation location

Make sure that the installation location meets the following conditions:

- ✓ The building is designed to withstand earthquakes.
- ✓ Far away from the sea to avoid salt water and humidity.
- ✓ The floor is flat and level.
- ✓ No flammable or explosive materials nearby.
- ✓ Optimal ambient temperature is between 15°C and 30°C.
- ✓ Temperature and humidity stay at a constant level.
- ✓ Minimal dust and dirt in the area.
- ✓ No corrosive gases present, including ammonia and acid vapor.

- ✓ The Residential ESS is rated at IP20, so the battery could be installed indoors.
- ✓ If the ambient temperature exceeds the operating range, battery will protect itself by shutting down. The optimal operating temperature of the battery is 15°C to 30°C. Frequent exposure to severe operating conditions would exacerbate the performance and lifetime of the battery.

4.2 Installation process

The battery should be installed according to the following flow chart.

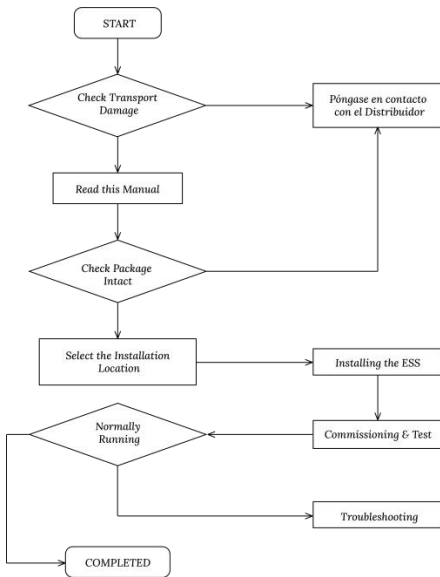

4.3 Installation materials

Following installation materials should be prepared by installers.

- ✓ Power cable
- ✓ Communication cable
- ✓ Earth wire

- ✓ Bipolar external isolators. When two or more battery systems are connected in parallel, each of them shall have a bipolar isolator.









NOTICE

Make sure that the cross-sectional area of charging cables is 25 to 35 mm².

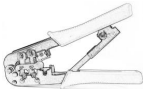
A breaker between battery and inverter is recommended to install, and its min. current should be over 150A or comply with local regulations.

4.4 Tools

To install the battery pack, those following tools are probably required:

			
Phillips screwdriver	Torque wrench	Cable crimper	Wire clamp
			
Voltmeter	Tape measure	Drill	Flat-head screwdriver

In order to protect the safety of operators and installers, it is necessary to select and employ suitable tools and measuring instruments that are certified for precision and accuracy.

4.5 Safety instruments

When dealing with the battery, following safety gears should be equipped. Installers must meet relevant requirements of IEC 60364 or domestic legislations and other relevant international standards.

		
Insulated glove	Safety goggles	Safety shoes

4.6 Communication cable

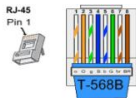

If needed, the network cable should be made as shown in that diagram. But the network cable between battery and inverter should be produced following the definition of inverter. If available, a LAN cable tester can be used to check whether the cable is faulty.

4.7 Storage

If the battery is not to be installed immediately, it should be removed from operation. It is secure and proper to be stored in an appropriate location, if long period storage is needed. Instructions for storage are:

- ✓ Do not stack more than 8 battery boxes.
- ✓ The temperature of battery stored is recommended in the range of 0°C to 45°C.
- ✓ Do not expose to water

The ESS box should be upright and not stacked upside down when being stored.

If the ESS needs to be stored over 3 months, the DC circuit of battery is suggested to be disconnected. Otherwise, the battery would discharge at a minimum rate and capacity degrades with storage time. Generally, the battery self-consumption is less than 5w. And, if the battery is stored over 6 months, it is suggested to connect the battery with inverter for system commissioning.

5 Battery Installation

5.1 Package items

These items are included in the package.



Battery*1



User Manual

5.2 Checks before installation

Check the battery voltage.

WARNING

If this checking process is executed for any reason after the battery is fully installed, make sure that the inverter is turned off or disconnected from battery while checking the battery.



Press and hold the panel button for about 4s, release it after the two LED lights on, and then measure the voltage at the terminal interface with a voltmeter. If the voltage is lower than 44 V, do not use the battery and contact customer careline or your distributor.

5.3 Installation of the battery

NOTICE



The symbol is located on the front of battery. For parallel or series connection, the earth wire must be installed.

Apply silica gel or paint around the earth terminal after the earth cable is connected.



5.3.1 Connect with 51.2Vdc Inverter

To prevent the battery from moving, make sure the battery is properly installed.

NOTICE

If the battery is installed above the floor or on a platform, make sure that the wall or platform is capable of supporting the battery's weight.

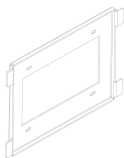
5.3.1.1 Wall mounting

NOTICE	
	<p>1. Use the wall mounting bracket to determine the installation position, the lower edge of the bracket should be at least 300mm from the ground, only one product can be installed on a wall bracket.</p>
	<p>2. Drill holes in the wall for M8 expansion screws, at least 50mm deep.</p> <p>3. fix four M8*50 expansion nails to the wall as shown, tighten the screws to a torque of approximately 2.5 N.m.</p> <p>4. fix the left and right brackets to the product using 6 x M6*12 cross recessed countersunk head screws as shown, tighten the screws to a torque of approximately 2.0 N.m.</p>



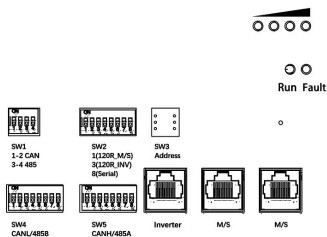















5.3.2 Address selection of Master and Slave Battery (Batteries) connection































































For series connection, please make sure the SW2 DIP switch is selected as this type.































WARNING

Please make sure the SW2 DIP switch is selected correctly. If the battery is connected in parallel mode, and SW2 DIP8 is selected at ON position, it probably leads to serious faults, even dangerous. Meanwhile, if battery is connected in series mode, and SW2 DIP8 is selected at OFF status, serious faults and hazards probably occur.

Connecte d battery number	Group	Set of SW2		Address Set (SW3)
		Series connection	Parallel connection	
1	—	 13	 13	 1
2	Master	 138	 13	 2
	Slave	 18	 1	 1
3	Master	 138	 13	 3
	Slave 1	 8	 0	 1
	Slave 2	 18	 1	 2

4	Master	 138	 13	 4
	Slave 1	 8	 0	 1
	Slave 2	 8	 0	 2
	Slave 3	 18	 1	 3
5	Master	 138	 13	 5
	Slave 1	 8	 0	 1
	Slave 2	 8	 0	 2
	Slave 3	 8	 0	 3
	Slave 4	 18	 1	 4
6	Master	 138	 13	 6

	Slave 1	 8	 0	 1
	Slave 2	 8	 0	 2
	Slave 3	 8	 0	 3
	Slave 4	 8	 0	 4
	Slave 5	 18	 1	 5
7	Master	 138	 13	 7
	Slave 1	 8	 0	 1
	Slave 2	 8	 0	 2
	Slave 3	 8	 0	 3
	Slave 4	 8	 0	 4

	Slave 5	 8	 0	 5
	Slave 6	 18	 1	 6
8	Master	 138	 13	 8
	Slave 1	 8	 0	 1
	Slave 2	 8	 0	 2
	Slave 3	 8	 0	 3
	Slave 4	 8	 0	 4
	Slave 5	 8	 0	 5
	Slave 6	 8	 0	 6
	Slave 7	 18	 1	 7

5.4 Cable connections

WARNING

Before connecting battery with inverter, please make sure the inverter turns off.

5.4.1 Cable connection for Series connection



NOTICE

The voltage difference of each battery should be less than 100mV.

5.4.2 Cable connection for Parallel connection



NOTICE

Before two or more batteries are installed in parallel, please check the voltage of each battery and make sure the voltage difference is less than 0.5V.

6 Settings for CAN /485 bus pins

SW4 is used for CAN low signal by inverter (CANL/485B),

SW5 is used for CAN high signal by inverter (CANH/485A).

As SW1 the CAN/485 DIP switch, installers should confirm which communication is suitable for the inverter

NOTICE

The battery default protocol is CAN bus. If an inverter communication mode is RS485 or other protocol, please contact customer careline before installing the battery.

7 Commissioning

7.1 Commissioning battery

If there is only one battery installed, the following steps are used to put it in operation:

- 1) Press and hold the panel button on the left side of the unit for about 4s, and release the panel button after the indicator lights on.
- 2) Make sure that the Run light is on. If it stays off, do not use the battery and contact your distributor.
- 3) Turn the inverter on, and wait for the start-up sequence to complete fully.

When there are two or more batteries connected with parallel mode, after the charging cable and the data cable are connected correctly, these steps are needed to follow to put them in operation:

- 1) Check and ensure the battery voltage level is above 44V.

If battery voltage is under 44V, please contact your distributor after service customer careline for help.

- 2) Press and hold the panel button for about 4s, and the indicator lights will turn on after four seconds.
- 3) Release the panel button.

For all batteries, make sure that the Run light is on.

- a. Make sure the maximum voltage difference between batteries is less than 2.0V.
- b. If not, the installer should balance the battery voltage and then connect batteries together in parallel.
- c. Set the DIP switches like part 6-3 Settings for CAN /485 bus pins.
- d. Turn the inverter on, and wait for the start-up sequence to complete fully.

7.2 Shutting down battery

Shut down the battery only when there is no charge or discharge current.

- 1) Press and hold the panel button for about 8s, and release it after a disconnected voice of relay comes out.
- 2) Make sure that every light on the battery is off.

Warranty of Residential ESS

This warranty specified below applies to RESS Lithium-ion Battery to consumers through authorized resellers. The accessories and tool kits provided are not included. In the event of a major failure of your unit, you will be entitled to obtain a replacement unit and your warranty will be transferred to the new unit. The units must only be utilized with controllers or equipment which is explicitly deemed compatible.

1 Purpose

The purpose of this warranty is to define the matters related to warranty policy of products.

2 Warranty Condition

2.1 Warranty Period

The product warranty period is 5 years from the sales date as mentioned in the Seller's invoice to End Users ("Invoice Date") or six(6) months from the date of manufacturing whichever comes first.

This warranty period covers a capacity equivalent to one (1) full cycle per day. Full cycle: Discharge the nominal capacity of a fully charged battery and fully charge it afterwards. Micro cycles sum up to full cycles according to amount of energy charged and discharged. Note: Products are unavailable to protect themselves from deep discharge/charging in condition of without communication connection.

The products without communication connection warranty period is 3 years (1 full cycle per day) from the sales date as mentioned in the Seller's invoice to End Users ("Invoice Date"). Regarding self-discharging degradation, it is guaranteed for 180 days after ex-work.

2.2 Limitation of Warranty scope

Under this Warranty, We are responsible for either battery replacement or battery repair. The Period of Performance Guarantee will continue on any repaired unit. In the event of a replacement units then the Period of Performance guarantee will transfer to the replacement unit.

In no event will be liable for any consequential, incidental or punitive damages(including without limitation of loss of profit, harm to goodwill or business reputation,or delay damages) arising from or out of the Product or its installation, use,performance or non-performance, or any defect or breach of warranty, whether based on contract, warranty, negligence, strict liability, or any other theory. Our aggregate liabilities, if any, in damages or otherwise, shall not exceed the purchase price paid by the Original Buyer for the product.

2.3 Exclusions of Warranty

Damage or impairment to the product resulting from any of following activities is NOT

covered by this warranty:

- ✓ Installation or use with any devices not approved as compatible.
- ✓ Failure to install or use the battery in the way intended, or as demonstrated in the installation manual including incorrect-installation of cables and connections.
- ✓ Failure caused by charger or inverter unit.
- ✓ Incorrect transportation, storage, installation or wiring by consumers or installers; if buyers fail to use the original packing materials provided by sellers during the transportation of equipment, any damage or failure of the product shall not fall under the warranty scope of the product.
- ✓ Mistreatment of the product including incorrect installation environment, incorrect temperatures or using the units other than in the specified manner.
- ✓ Damage caused by any impact, physical trauma to the unit such as dropping or mishandling.
- ✓ Attempts to change the functionality of the unit in any way, exposure of the product influenced by movement or shaking following installation, or temperatures of more than 55°C or below -10°C.
- ✓ Using the battery outside of the clearly stated performance criteria for the unit.
- ✓ Water ingress, corrosive gas damage or installation in dirty environments causing particles to affect performance.
- ✓ Anyone other than those authorized may not modify, disassemble, repair or replace the product.
- ✓ The unit must carry clearly identifiable and authentic serial number and labels.
- ✓ Products suffered any external influences including unusual physical force, electrical stress (power failure surges, inrush current, lightning, flood, fire, accidental breakage, etc.).
- ✓ Extensive superficial damage to the case demonstrating impact or mishandling or poor protection of the battery.
- ✓ Product damage and defect caused by deliberately or willful acts.
- ✓ Product failure not reported to the seller or authorized service partner within 1 week of appearance.
- ✓ The product not being operated for any period of 6 months or more.
- ✓ Unusual physical or electrical stress caused by force majeure, such as power failure surges, inrush current, lightning, flood, fire, accidental breakage, etc.;

3 Performance Warranty

Guarantees that Residential ESS Lithium-ion Battery will retain greater than or equal to 70% of output energy capacity for 5 years from the Invoice date and follow the specification as well as the user manual provided.

Capacity measurement conditions (referenced IEC: 62619)

- ✓ Ambient temperature: $25 \pm 2^{\circ}\text{C}$
- ✓ 80%DoD
- ✓ Total energy/Usable energy measured under specific conditions from 0.2C CC/CV at DC side.

But, if you suspect our verification, the product must be tested by an EU certified origination or a certified 3rd party testing company. Meanwhile, any 3rd party evaluation service fees shall be at your own expense, unless your claim is proven to be valid, in which case will be responsible for the testing costs.

4 Warranty Policy

If the product is not of acceptable quality upon arrival, the customer is entitled to request product repair or replacement.

5 About Service Products/Parts

Service products or accessories could be used as new or refurbished condition and guarantees relevant performance is equal to or higher than replaced device.

If the product is no longer sold in the market, promises to replace it with different kinds of products with equal or higher functions and performances, or the residual annual depreciation value of the paid price by the buyer within the time limit for performance guarantee.

6 Claim Policy

Whether to repair or replace the product will be determined in its sole discretion. Claims under this warranty must be proposed from authorized distributors who purchased the product. Meanwhile, you must notify your distributor of a claim by:

- ✓ Give a call or email to your distributor;
- ✓ Contract with hotline or email us directly within 48 hours of a faulty discovered.
- ✓ The following items must be included:
- ✓ The original purchase receipt or equal valid document;
- ✓ Description of the alleged defect(s) to your distributor after contacting service hotline or sending an email;
- ✓ The product's serial number and the initial installation date.

If the battery is suspected to be faulty, the unit should be returned to appointed distributors at the cost of customers at approved costs. If the unit is deemed faulty after inspection by designated experts, we will dispatch a REPLACEMENT or FIXED unit and credit the cost of returning the unit to us for testing (based on standard acceptable logistical costs).

7 Out Of Warranty

In the event the product is out of warranty, may (in its discretion) provide certain after-sales service to Original Buyer, but all related costs and expenses, such as parts, labour costs and travel expenses, shall be borne by Original Buyer. To request such after-sales service, Original Buyer must provide sufficient information about any defects, to enable authorized service partner to determine whether such defects are capable of being repaired.

RED Declaration of Conformity (DoC)

We,

Manufacturer's name: CF ENERGY CO., LTD.

Manufacturer's address: Workshop No.18, Demonstration Base of Traditional Industry Transformation, High-tech Zone, Qindu District, Xianyang City, Shaanxi Province, PEOPLE'S REPUBLIC OF CHINA

declare under our sole responsibility that the product:

Product name: Lithium-ion battery

Type or model: CFE-10H

to which this declaration relates is in conformity with the essential requirements and other relevant requirements of the RED Directive (2014/53/EU).

The product is in conformity with the following standards and/or other normative documents:

HEALTH & SAFETY (Art. 3(1)(a)): IEC 62040-1:2017, IEC 62619:2017, EN 62311:2008; EN 50665:2017

EMC (Art. 3(1)(b)): EN IEC 61000-6-1:2019, EN 61000-6-3:2007/A1:2011, EN 301 489-1 V2.2.3:2019, Draft EN 301 489-17 V3.2.2:2019

SPECTRUM (Art. 3(2)): EN 300 328 V2.2.2:2019

Technical file held by: CF ENERGY CO., LTD.

Place of issue: Xianyang PRC

Date of issue: December 14, 2021

Signed:



Teddy Du
QA Director
CF Energy Co., Ltd.



First-class power battery system supplier

First-class supplier of energy storage and microgrid

CF Energy Co., Ltd.

Company Address:

Intelligent Manufacturing Base , Xianyang ,

Shaanxi , PRC .

Tel: (+86) 029-38367888

Web: www.cfess.cn

E-mail: eva.lin@cfess.cn